



Slings, Surveys and Safety

- **Chain Sling Inspection**
- **Rejection Criteria**
- **Proper Use of Slings**
- **Safe Lifting Practices**
- **Clamp Operating Guide**



The Campbell chain sling safety program....

Campbell's program is threefold: Inspection, evaluation and instruction. Sling surveys assure compliance with OSHA and ASME/ANSI standards and in many cases reduce downtime costs of material handling.

Campbell chain has developed this booklet to aid in the selection, use, and maintenance of chain slings and clamps. As with any quality product, certain precautions and standards of treatment should be observed.

Repair and reconditioning - Campbell sling repair centers across the U.S. help make the most of your chain sling and clamp investment. An in plant sling inspection often reveals slings and clamps that can be economically reconditioned.

Table of Contents -

Chain Slings

Chain Definitions	4
Chain Inspection Programs	5
Seven Sling Danger Signs	6
Inspection Procedure.....	7
Rejection Criteria.....	8 - 11
Proper Use of Chain Slings	12 - 15
OSHA 1910.184	16
Basic Types of Chain Slings	17
Work Load Limit Charts	18 - 22
Shackle Loading (*)	23
Eyebolt Loading (*)	24

Lifting Clamps

Definitions	26 - 28
Operating Guidelines	29 - 31
Clamp Inspection & Repair	32 - 34

(*) Reprinted from ASME B30.26-2005, by permission of The American Society of Mechanical Engineers. All rights reserved.

Chain Definitions & Terminology

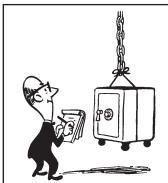

Work Load Limit-

The maximum load in pounds, in straight tension, at which a chain can safely be used.

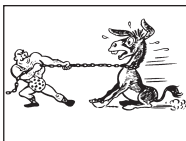

Proof Test-

The load in pounds that the chain has been subjected to prior to leaving the Campbell plant.

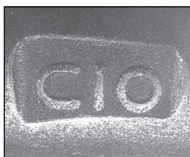

Hallmarking-

(embossing) The method of placing an identification mark on a chain link which identifies the grade of chain and the manufacturer.

Elongation-

The amount (%) of stretch a chain exhibits from the proof test to the breaking point of the chain, determined by representative testing.

Chain Sling Inspections

A good chain sling inspection program should provide a complete recorded history of each sling. By keeping a running history of all slings, changes in its condition can be monitored and compared over its service life. Slings are required by OSHA 1910.184 and the ASME B30.9 to undergo inspections. Inspections are broken down into three types:

A) Initial Inspection - Prior to use all new, altered, modified, or repaired slings shall be inspected.

B) Frequent Inspection - A visual inspection of the sling shall be made each day the sling is used, usually made by the user of the sling.

C) Periodic Inspection - A complete and thorough link by link inspection of all the components of a chain sling. The time between inspections depends on severity of sling service, but should not exceed one year. Written records of the periodic inspections should be made and kept.

Recognize these seven sling danger signs?



Burned links. Cause: welder arcing or using sling as a ground



Nicks, gouges and bent links. Cause: wrapping unprotected sling around sharp corners or setting loads on chain



Corrosion pits. Cause: leaving slings outside or in corrosive environment



Excessive link wear. Cause: lack of regular periodic inspection program



Stretch and deformation. Cause: overloading chain; angular lifting



Open or deformed sling hook. Cause: loading hook off center of bowl or point loading



Abrasion. Cause: dragging chain across the floor or pulling it out from under loads

Procedure for Periodic Inspection

- 1) Inspections should be made in an area with adequate room to work and with enough lighting to easily examine the sling.
- 2) A dirty chain sling should be cleaned so that defects may be more easily detected.
- 3) When possible, hang the sling vertically for the preliminary inspection and to measure the length. When not possible to hang the sling, lay the chain out on a level surface with all the twists removed to measure the reach (length).
- 4) Measure the reach of each leg of the sling. Measure from the bearing point of the master link to the bearing point of the hook. An increase in length may indicate that the chain has been overloaded and stretched.
- 5) Perform a detailed examination of the sling including the contact areas of each chain link, master and hooks.
- 6) Record the results of the inspection.
- 7) If any potentially defective conditions are discovered, the sling should be removed from service. The sling should not be returned to service until it is repaired or approved for use by a qualified person.

Rejection Criteria

1) Missing Identification Tag:

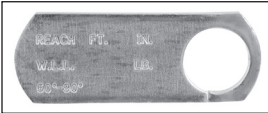

All chain slings are required to be identified with the manufacturer's trademark

or symbol, the chain grade and size, the number of legs, the reach and the working load limit and the angle upon which it is based.

2) Excessive Wear, Nicks, or Gouges:

Every link and component of a sling should be examined for evidence of wear, nicks, gouges, pressure marks, and drag abrasions. It is important to examine the bearing areas (link ends), as this is a prime location for wear. Sharp or deep cuts across the chain links are more serious than shallow rounded grooves running in the wire direction.

Wear: If the minimum thickness at any location on the chain falls below that listed in Table 1, the sling must be removed from service. As a general rule, if any dimension of any component is worn more than 10% from the original dimension the sling should be removed from Service.

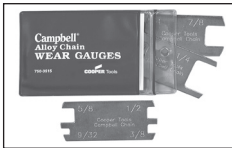

Campbell Grade 10

Minimum Wear Gauges
Part Number 7503515

Table 1: Minimum thickness Criteria.

Remove sling if below listed value.

Chain Size In	mm	Catalog Number	Actual		Minimum	
			In.	mm	In. mm	In. mm
7/32"	5.5	0400312	.218	5.5	.189	4.80
9/32"	7.0	0405212	.282	7.16	.239	6.07
3/8"	10.0	0405412	.402	10.21	.342	8.69
1/2"	13.0	0405512	.522	13.25	.443	11.26
5/8"	16.0	0405612	.643	16.33	.546	13.87
3/4"	20.0	0405712	.802	20.37	.687	17.45
7/8"	22	0405812	.881	22.37	.750	19.05
1"	26.0	0401612	1.00	25.4	.887	22.53
1 1/4"	32.0	0402012	1.25	31.75	1.091	27.71

3) Cracked or Broken Links or

Components: The presence of cracks or broken components on a sling are rejectable conditions. Cracks may occur more frequently around areas of other damage such as bend and pressure marks on chain. Other locations are areas that have experienced a high degree of sliding wear such as master links and bowls of hooks.

4) Bent, Twisted , or Deformed Chain

or Components: Chain links or other sling components that are bent, twisted or deformed are evidence that the chain sling has been overloaded or abused in some manner and are rejectable.

5) Stretched or Elongated Chain:

Stretched chain, coupling links, or master links are evidence of overloading and are cause for removal from service.

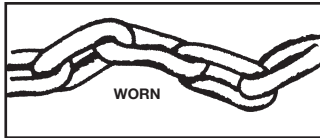

Inspection tip - The chain segments adjacent to the master link generally experience less severe use and abuse than the chain adjacent to the hook. Comparing these two areas of a chain leg side by side can be a way to look for elongated links.

6) Discoloration (Exposure to Heat, Welding, Chemicals): Slings that show unusual color may have been exposed to excessive heat or harmful chemicals. If these conditions are present, the sling should be removed from service until its exposure is known.

Note: See Campbell Sling Catalog #55496-03 for “Effect of Elevated Temperature” on the Working Load Limit of Grade 8 and Grade 10 Alloy Chain.

Chemicals - Chemically active environments may adversely affect chain slings.

Do not use in highly acidic or caustic environments, including Galvanizing operations. Consult Campbell before use.

Welding or Weld Spatter - Any evidence of welding after initial manufacture or weld spatter on the chain sling is cause for removal. Welding will destroy the original heat treatment of the chain.

Weld spatter is cause for removal from service



7) Excessive Corrosion (Rust): Slings should be stored in a location that minimizes rust and corrosion. Slings should be removed from service if severely pitted, or are corroded where large flaky rust is present and easily flakes off, or if the chain components are severely pitted.

Proper Use of Chain Slings

To protect the operators, the load and the sling, the following safe practices should be followed. Campbell also recommends compliance with OSHA and ASME safety standards.

1) Select a sling suitable for the load, type of hitch, angle of loading, and environment. The hooks and master links should be of a size to fit the intended connections. Know weight of object to be lifted.



2) Inspect chain sling before use.

3) Pad all sharp edges or corners in contact with the sling to prevent damage to sling or load.

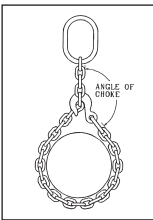
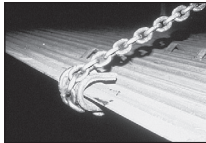

4) Diameter of the contact area for basket and choker hitches should be a minimum of 10 times diameter of chain.

5) Rig so that the load is properly seated in the hooks and master link. Avoid tip loading of hooks and side loading of master links.

How Off-Center (Tip) Loading Reduces Working Load Limit of 1/2" Alloy Hook

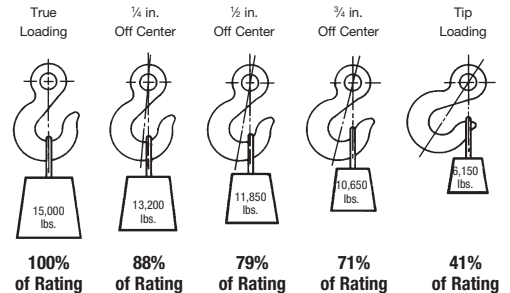

6) Avoid twisting or kinking of sling legs.



7) Never knot or twist chain legs to shorten length.



8) Load shall not be suspended over people.

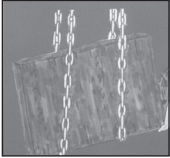

9) Balance the load to prevent shifting and to maintain control of the load.

10) Avoid shock loading of sling.

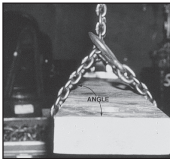
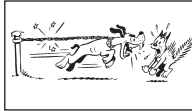

11) Choker hitches reduce the working load limit of the sling by 20%. Further reduction in working load occurs when the angle of choke is less than 120 degrees.

12) When not in use, store chains out of harms way and in a clean, dry area, preferably on a rack.



13) Avoid abrasive wear. Don't drag chain across the floor or from under static loads.



14) Never permit anyone to ride the lifting hook or the load.

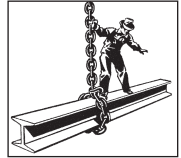

How Lifting Angles Reduce Work Load Limit of Slings

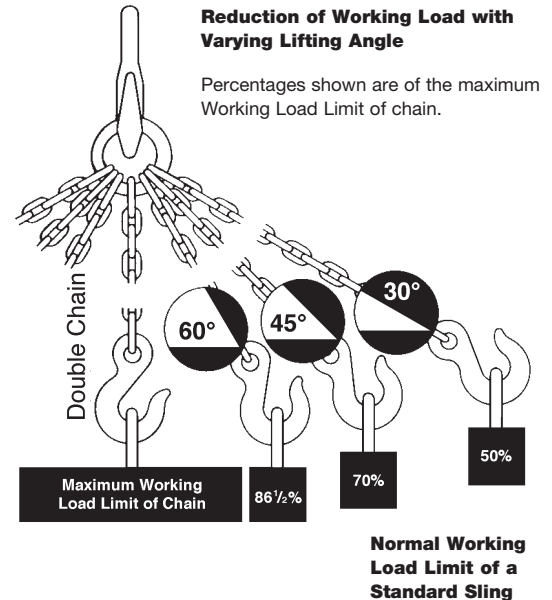

OSHA 1910.184 Industrial Slings

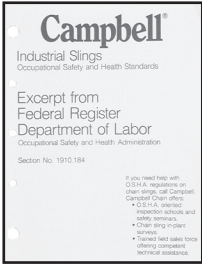

O.S.H.A.
Excerpt from Federal Register
Department of Labor
Section No. 1910.184
Cooper No. 550201

Inspections

- Daily before use
- Additional as warranted
- Frequency of use
- Nature of lifts
- Past experience
- Minimum 1 per year



Record Keeping

Most recent report.
Annual written report.
Must maintain test certificates

Identification Tags

Size, Grade, Rated capacity,
Reach, Type, and Sling
Manufacturer



Basic Types of Chain Slings. Type DOS

Chain Slings are designated throughout the industry by symbols. They are listed in the chart below.

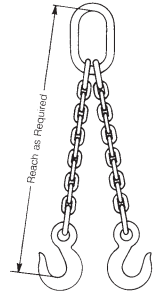

Type DOS

First Symbol - (Basic Type)

- S** Single Chain Sling with master link and hook, or hook each end.
- SB** Single Basket Sling
- C** Single Choker Chain Sling with master link each end. No hooks.
- D** Double Chain Sling with standard master link and hooks.
- DB** Double Basket Sling
- T** Triple Chain Sling with standard master link and hooks.
- Q** Quadruple Chain Sling with standard master links and hook.

Second Symbol - (Upper End Fitting)

- O** Standard Oblong Master

Third Symbol - (Lower End Fitting)

- S** Sling Hook
- G** Grab Hook
- F** Foundry Hook

Campbell® Cam Alloy Chain Slings

Grade 100 Working Load Limits (lb) *

Trade Size	GRADE	Single Slings (Type S)			Double (Type D) and Single Basket (Type SB) Slings			Triple (Type T), Quadruple (Type Q) and Double Basket (Type DB) Slings			
		90°	60°	45°	30°	60°	45°	30°	60°	45°	30°
9/32	100	4,300	7,400	6,100	4,300	11,200	9,100	6,400			
3/8	100	8,800	15,200	12,400	8,800	22,900	18,700	13,200			
1/2	100	15,000	26,000	21,200	15,000	39,000	31,800	22,500			
5/8	100	22,600	39,100	32,000	22,600	58,700	47,900	33,900			
3/4	100	35,300	61,100	49,900	35,300	91,700	74,900	53,000			
7/8	100	42,700	74,000	60,400	42,700	110,900	90,600	64,000			

*Warning: Do not exceed Working Load Limit

Campbell® Cam Alloy Chain Slings

Grade 80 Working Load Limits (lb) *

Trade Size	GRADE	Single Slings (Type S)			Double (Type D) and Single Basket (Type SB) Slings			Triple (Type T), Quadruple (Type Q) and Double Basket (Type DB) Slings			
		90°	60°	45°	30°	60°	45°	30°	60°	45°	30°
7/32	80	2,100	3,600	3,000	2,100	5,500	4,400	3,200			
9/32	80	3,500	6,100	4,900	3,500	9,100	7,400	5,200			
3/8	80	7,100	12,300	10,000	7,100	18,400	15,100	10,600			
1/2	80	12,000	20,800	17,000	12,000	31,200	25,500	18,000			
5/8	80	18,100	31,300	25,600	18,100	47,000	38,400	27,100			
3/4	80	28,300	49,000	40,000	28,300	73,500	60,000	42,400			
7/8	80	34,200	59,200	48,400	34,200	88,900	72,500	51,300			
1	80	47,700	82,600	67,400	47,700	123,900	101,200	71,500			
1 1/4	80	72,300	125,200	102,200	72,300	187,800	153,400	108,400			

*Warning: Do not exceed Working Load Limit

Rated Loads for Grade 100 Alloy Steel Chain Slings - Choker Hitches

Chain Size Nominal in. mm	Single Leg			Double Leg and Single Baskets						Triple and Quadruple Leg; Double Baskets					
	90°		lb	60°		45°		30°		60°		45°		30°	
	lb	kg		lb	kg	lb	kg	lb	kg	lb	kg	lb	kg	lb	kg
7/32 5.5	1,700	750	2,900	1,300	2,400	1,100	1,700	750	4,400	1,950	3,500	1,600	2,550	1,150	
9/32 7	3,500	1,600	6,100	2,750	4,900	2,250	3,500	1,600	9,100	4,150	7,400	3,400	5,200	2,400	
3/8 10	7,100	3,200	12,300	5,550	10,000	4,550	7,100	3,200	18,400	8,300	15,100	6,800	10,600	4,800	
1/2 13	12,000	5,400	20,800	9,450	17,000	7,700	12,000	5,400	31,200	14,150	25,500	11,550	18,000	8,200	
5/8 16	18,100	8,200	31,300	14,200	25,600	11,600	18,100	8,200	47,000	21,300	38,400	17,400	27,100	12,300	
3/4 20	28,300	12,800	49,000	22,250	40,000	18,150	28,300	12,800	73,500	33,400	60,000	27,250	42,400	19,300	
7/8 22	34,200	15,500	59,200	26,850	48,400	21,900	34,200	15,500	88,900	40,250	72,500	32,900	51,300	23,250	

Note: Angle of choke should be greater than 120°

Rated Loads for Grade 80 Alloy Steel Chain Slings - Choker Hitches

Chain Size Nominal in. mm	Single Leg			Double Leg and Single Baskets						Triple and Quadruple Leg; Double Baskets					
	90°		lb	60°		45°		30°		60°		45°		30°	
	lb	kg		lb	kg	lb	kg	lb	kg	lb	kg	lb	kg	lb	kg
7/32 5.5	1,700	750	2,900	1,300	2,400	1,100	1,700	750	4,400	1,950	3,500	1,600	2,550	1,150	
9/32 7	2,800	1,300	5,000	2,200	3,900	1,800	2,800	1,300	7,300	3,300	5,900	2,700	4,150	1,900	
3/8 10	5,700	2,550	9,800	4,450	8,000	3,650	5,700	2,550	14,700	6,650	12,100	5,450	8,500	3,850	
1/2 13	9,600	4,300	16,600	7,550	13,600	6,150	9,600	4,300	25,000	11,300	20,400	9,250	14,400	6,550	
5/8 16	14,500	6,550	25,000	11,350	20,500	9,300	14,500	6,550	37,600	17,050	30,700	13,900	21,700	9,850	
3/4 20	22,600	10,250	39,200	17,800	32,000	14,500	22,600	10,250	58,800	26,700	48,000	21,800	33,900	15,450	
7/8 22	27,400	12,400	47,400	21,500	38,700	17,500	27,400	12,400	71,100	32,200	58,000	26,300	41,000	18,600	
1 26	38,200	17,300	66,100	30,000	53,900	24,500	38,200	17,300	99,100	45,000	81,000	36,750	57,200	26,000	
1-1/4 32	57,800	26,250	100,200	45,450	81,800	37,100	57,800	26,250	150,200	68,150	122,700	55,700	86,700	39,350	

Note: Angle of choke should be greater than 120°

Grade 10 Standard Sling Working Load Limits

Chain Size	Single Slings Single Adjustable (Styles A & B)		Double & Dbl. Adj. A & B Double Endless Basket Single Basket		Triple Slings Quadruple Slings Double Adj. Loop A & B Double Basket				
	Vertical @90°	Choker @60°	Basket @60°	Bridle @60°	Choker @60°	Basket @60°	Bridle @60°	Choker @60°	Basket @60°
9/32"	4,300	3,500	7,400	7,400	6,100	7,400	11,200	9,100	11,200
3/8"	8,800	7,100	15,200	15,200	12,300	15,200	22,900	18,400	22,900
1/2"	15,000	12,000	26,000	26,000	20,800	26,000	39,000	31,200	39,000
5/8"	22,600	18,100	30,000	39,100	31,300	39,100	58,100	47,000	58,700
3/4"	35,300	28,300	45,200	61,100	49,000	61,100	91,700	73,500	91,700
7/8"	42,700	34,200	70,600	74,000	59,200	74,000	110,900	88,900	110,900

Shackle Loading Reduction in Working Load Limit with Angular Lifting

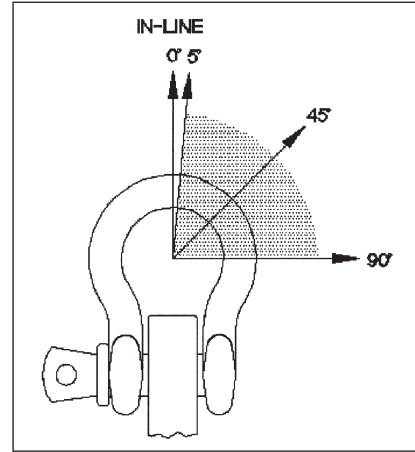

Side Load Angle	% Load Reduced
In-line 0 to 5°	None
5° to 45°	30%
46° to 90°	50%
Over 90°	Not Recommended

In-line 0 to 5°
5° to 45°
46° to 90°
Over 90°

None
30%
50%
Not Recommended

- Screw pin shall be fully engaged
- Multiple sling legs should not be applied to the shackle pin
- Do not shock load
- Center load on bow and pin

Reprinted from ASME B30.26-2005, by permission of The American Society of Mechanical Engineers. All rights reserved.

Eyebolt Loading

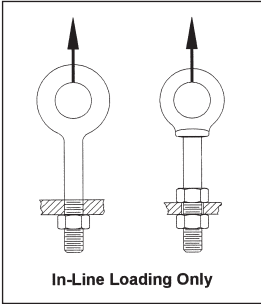

Eyebolts not shouldered to the load shall only be used for in-line loading.

Avoid shock loading.

Tighten securely.

Loading Angular Loading

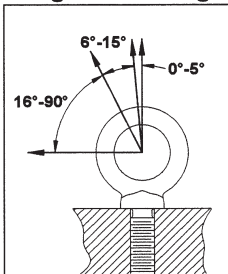

Vertical Angle	% of Rated Load
0° - 5°	100%
6° - 15°	55%
16° - 90°	25%

Reprinted from ASME B30.26-2005, by permission of The American Society of Mechanical Engineers. All rights reserved.

Campbell®

Lifting Clamps Operating Guidelines for Safe Material Handling

Campbell lifting clamps, like many other products, are often used in work environments which can be dangerous. It would be impossible to describe in any manual all of the ways that a product could be misused. Campbell warnings are intended to identify only the most common risks. As a distributor or end user, it is your explicit responsibility to identify the risk factors before putting any product into service.

If you have any doubts as to the clamp best suited to your application, contact your Cooper Hand Tools distributor.

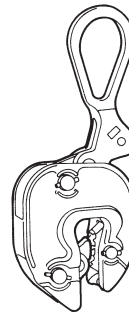

Model "GX" Clamp

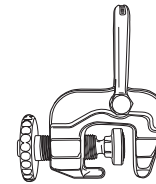

Plate Clamp with
Screw-adjusted Cam



Locking "E" Clamp

Definitions

1. Vertical lift: The lifting of a vertical plate or member in which the lifting force exerted by the rigging is evenly distributed and is directly above and in line with the clamp's lifting shackle. This is illustrated above.

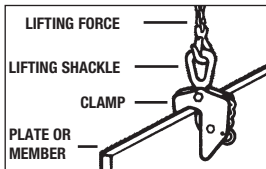

2. Vertical turn/lift: A vertical turn/lift clamp is one designed to turn a single plate or member from horizontal to vertical through a 90° arc; or from horizontal to vertical to horizontal through a 180° arc.

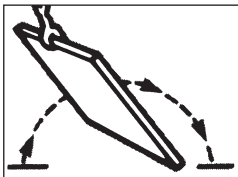

3. Horizontal lift: Multiple clamps are attached to the sides of a horizontal plate. The clamps are attached to a multi-leg sling centered over the plate. Refer to illustrations.

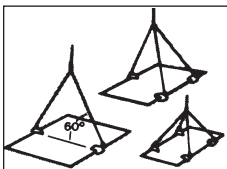

Warning: The capacity of all horizontal clamps is based on a sling angle of 60°. See illustration (right). Sling angles less than 60° increase the load exerted on the clamps.

4. Finished and polished plates: Steel plates such as stainless which have other than hot rolled surfaces are generally handled with non-marring clamps having at least one smooth gripping surface. Extra caution is therefore required.

Definitions, continued

5. Structural members and fabricated sections:

Unless otherwise specified, clamps recommended for structural members and fabricated sections are limited to hot rolled steel products with a Brinell hardness not exceeding 400. For other or unusual applications, contact CooperTools for lifting recommendations.

6. Rated capacity: The rated capacity of a Campbell clamp is based on a clamp in “new” or “as new” condition. It represents the maximum load the product is to be subjected to when used in a manner described in this manual. Wear, misuse, abuse and other factors relating to usage may reduce the rated capacity. Shock loading and the factors listed above must be taken into consideration when selecting a Campbell clamp for a given application.

7. Working load limit: The maximum load that should ever be applied to a Campbell clamp. The working load limit is forged or stamped on the body of every clamp. Each clamp is tested in excess of the working load limit.

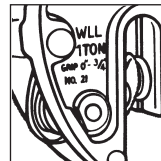

8. Maximum and minimum plate thickness: The size plate a clamp is capable of lifting.

Warning: Never lift a plate that is not within the grip range forged or stamped on the clamp.

9. Jaw opening: The capacity (grip range) of a clamp in terms of plate thickness.

Warning: Never lift a plate that is not within the grip range forged or stamped on the clamp.

- 10. Operating temperatures:** Unless otherwise specified in the application section of this manual, Campbell clamps are designed to operate only in temperatures ranging from 0°F to 200°F. This range applies to both the ambient and material temperatures.

Warning: Contact Campbell Chain before using Campbell clamps in temperatures not within this range.

- 11. Locking clamps:** Clamps equipped with a lever or spring, a tension arm and a chain-pull that places and keeps the cam in contact with the plate. The mechanism facilitates attaching and removing the clamp.

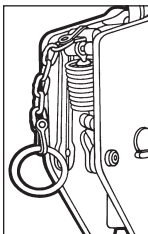

Warning: Never tamper with a clamp's locking mechanism during a lift.

- 12. Lock open-lock closed:** A lever or chain activated spring holds the cam away from or in contact with the plate, and this makes clamp operation easier. The Campbell "GXL" and "E" clamps have this feature. These clamps will not lift plate when in the "lock open" position.

- 13. Warning:** A notice pointing out danger, apprising the operator and others that they should protect themselves.

Operating Guidelines

- 1. Know the application.** Before using any Campbell clamp, refer to the application section of this manual to be sure the lift to be made is appropriate for this style clamp.

- 2. Determine the weight of the load.** Every Campbell clamp has its rated weight capacity and grip range forged or stamped into the body. Always use a clamp with a grip and lifting capacity in excess of the thickness and weight of the plate or member being lifted. Match the clamp to the load. Don't use a big clamp lift a small load.

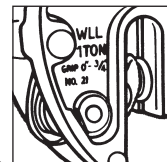

- 3. Inspect clamp before each lift.** Refer to the maintenance and inspection pages of this manual for details.

- a. Check the cam and pad for excessive wear. If one of the surfaces is approaching the maximum allowable wear, it should be replaced. If either the cam or pad must be replaced, it is recommended that the other be replaced also.
- b. Check the shackle and visible linkage to be sure they are not bent or excessively worn. If so, replace them.

Warning: Do not try to straighten any bent component. Replace it. Do not use any clamp in need of repair, or that has been overloaded.

- 4. Use only the manufacturer's recommended replacement parts.**

5. **Do not lift more than one plate at a time.**

6. **Position the clamp to balance the load.** Position the clamp so the lifting force exerted by the crane is directly in line with the lifting shackle and the load is evenly distributed.

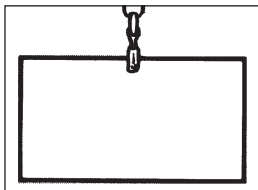
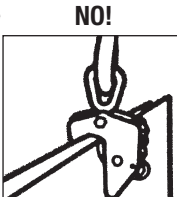

Warning: Beware of side loading. Never exceed an angle of 10° from vertical (20° from vertical for SAC and MPSAC) when using a clamp.

Use at least two clamps and a spreader bar when lifting long plates or shapes. Do not exceed the combined WLL of two clamps when using two or more clamps.

7. **Insert plate to full depth of throat opening.** It is imperative that the cam and pad have maximum contact on the plate to insure a good firm grip on the plate being lifted.

8. **Lift slowly and smoothly.**

Do not jerk load. Shock loading can damage the clamp.

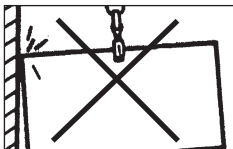

Warning: Great care should be taken to not bump or lessen the load on the cam, which may cause clamps to release.

9. **Stay clear of load when lifting.**

The operator should stay clear of load and should never lift over other people or machinery.

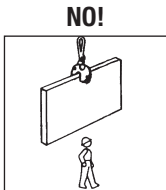

10. **Never alter a clamp.** Clamp manufacturer's specifications include specific materials and manufacturing procedures. Never grind, weld or in any way alter clamp, as this could cause severe damage or fatigue.

11. **Do not misuse a clamp.**

Never lift a plate from the bottom of a stack. Never lift horizontally using a vertical lifting clamp. Do not improvise.

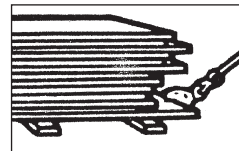

12. **Never attach a clamp directly to the crane hook.** Use a sling between the crane hook and clamp to minimize interference in clamp operation and its ability to maintain a proper position on the plate.

13. **Always place pad side (short leg) of clamp under plate** when lifting from horizontal to vertical with clamps other than the GX models.

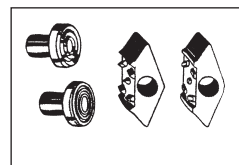

14. **Lift one plate at a time.**

15. **Do not rush. Lift slowly and smoothly.**

Inspection

- 1. Inspection of Cams.** Inspect the cam for chipped or worn teeth. Teeth must be free of foreign matter. Inspect the cam for fractures. The cam on a SAC clamp should swivel freely about the screw. If it does not swivel properly, remove the cam from the screw and inspect inside the cam and screw ball head.

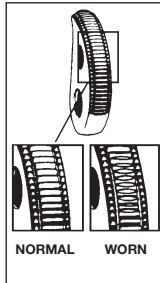

WARNING!: Cams with fractures, worn or chipped teeth must be replaced. If any one tooth is worn or chipped more than 50% along the length of its crown, replace the cam. Replace the pad at the same time.

2. Inspection of Pads.

Campbell clamps utilize a fixed pad or swivel pad. Inspect the pad for worn or chipped serration. Serration must be free of foreign matter.

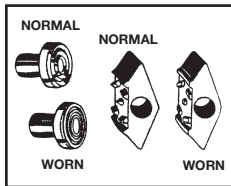

WARNING!: Pads with worn or fractured serrations must be replaced. If any one tooth is worn or chipped more than 50% along the length of its crown, replace the pad. Replace the cam at the same time.

3. Inspection of Shackles.

- A.** Inspect the shackle for bending at the rivet section, which is an indication of side pull.
- B.** Inspect the shackle eye for elongation.
- C.** Inspect the shackle for fractures.

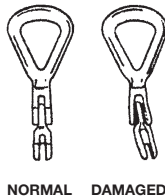

4. Inspection of Clamp's Body.

- A.** Inspect the throat width of the clamp. The width at the base should be the same as at the top.
- B.** Inspect the weld and external surfaces for fractures, wear or distortion.
- C.** Inspect the body rivets for worn heads.

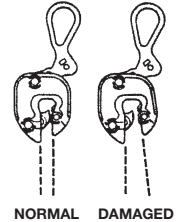

5. Inspection of Springs.

- A.** Inspect spring for distortion.
- B.** Inspect spring for fractures.
- C.** Inspect spring for sufficient tension. To do so, when the clamp is fully assembled and in the locked position, the spring should be strong enough to hold the cam against the pad.

WARNING!: Elongated or fractured springs must be replaced.

6. Inspection of Cam Screws (On SAC and MPSAC).

- A.** Inspect screw for distortion, worn or damaged threads.
- B.** The ball head where the cam mounts should be free of foreign matter, allowing the free rotation of the cam.

WARNING!: Do not over-tighten! Screw needs to be hand tight only.

7. Inspection of Linkage Rivets.

- A. Inspect rivets for loose connections.
- B. Inspect rivets for wear or fractures.
- C. Inspect rivets for bending.

NORMAL

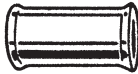

WORN



8. Inspection of Pins.

- A. Inspect the pins for distortion.
- B. Inspect pins for fractures or wear.

9. Inspection of Chains.

Chains supplied with clamps should also be inspected carefully.

To do this, use a

Campbell wear

gauge. Inspect

chains link by link,

checking for distorted, stretched or cracked links, nicks or gouges, pitted links and excessive wear of bearing surfaces and barrels.

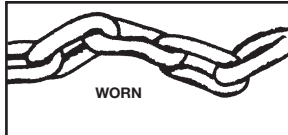

Notes

Distributed by: